



Zoning Resolution

THE CITY OF NEW YORK
Zohran K. Mamdani, Mayor

CITY PLANNING COMMISSION
Sideya Sherman, Chair

139-543 - Special design standards for lighting

File generated by <https://zr.planning.nyc.gov> on 6/9/2026

139-543 - Special design standards for lighting

LAST AMENDED

11/23/2021

The lighting requirements of [62-653](#) (Lighting) shall be modified such that an average maintained level of illumination not less than 0.5 horizontal foot candle (lumens per foot) shall be provided throughout all walkable areas, and the average illumination to minimum foot candle uniformity ratio shall be no greater than 6:1 within any #waterfront public access area#.

In addition, fixtures providing the required lighting along any public access area shall comply with the lightpost illustration in this Section, or shall be of a comparable design which is the minimum modification needed. Where modification is sought, it shall be deemed suitable by the Chairperson of the City Planning Commission in consultation with the by the New York City Department of Transportation (DOT).

Fixtures providing supplemental lighting beyond the requirements of this Section need not comply with this illustration.

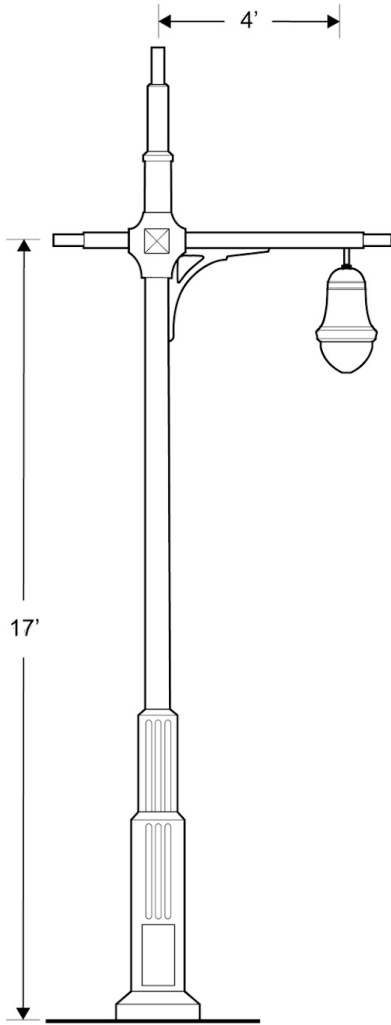

LIGHTPOST
Side Elevation

The lightpost shall conform to the street lighting standard drawings for a 17 foot “TBTA” short pole with “Tear Drop Luminaire” set forth by the DOT.