



## **Zoning Resolution**

**THE CITY OF NEW YORK**  
**Zohran K. Mamdani, Mayor**

**CITY PLANNING COMMISSION**  
**Sideya Sherman, Chair**

# **95-033 - Location of transit easements**

File generated by <https://zr.planning.nyc.gov> on 6/13/2026

---

## 95-033 - Location of transit easements

---

LAST AMENDED

11/30/2017

The transit easement volume may be located within a #building#, in open areas, including #public plazas#, or in areas covered by projected overhangs of a #building#. At least one vertical face of the easement volume shall be at a #front lot line#. The easement volume shall be located on the #zoning lot# as close as possible to the #street# containing the transit line.

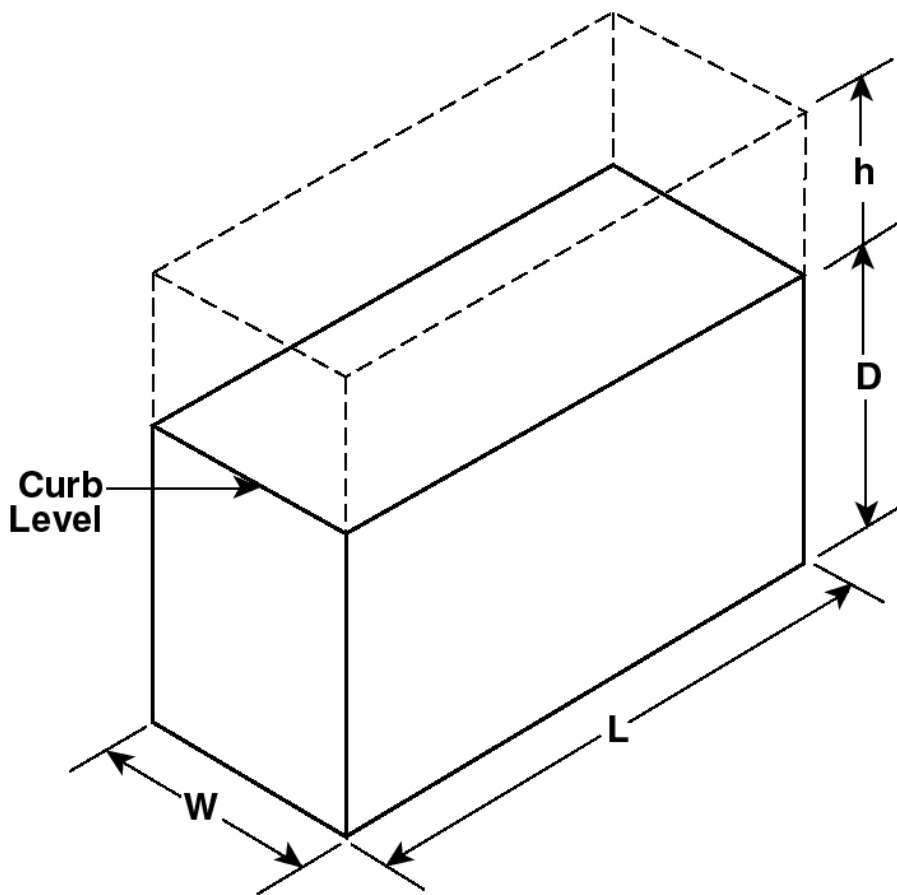

**h** – Height above curb level

**D** – Depth below curb level

**L** – Length

**W** – Width

TRANSIT EASEMENT VOLUME

[\(95-032\)](#)