



## **Zoning Resolution**

**THE CITY OF NEW YORK**  
**Zohran K. Mamdani, Mayor**

**CITY PLANNING COMMISSION**  
**Sideya Sherman, Chair**

# **23-421 - Basic pitched-roof envelopes for certain districts**

File generated by <https://zr.planning.nyc.gov> on 6/8/2026

---

## 23-421 - Basic pitched-roof envelopes for certain districts

---

LAST AMENDED

12/5/2024

R1 R2 R3A R3X R3-1 R3-2 R4 R4-1 R4A R5A

In the districts indicated, the height and setback regulations for #single-# or #two-family# #detached#, #semi-detached#, or #zero lot line# #buildings or other structures#, where permitted, shall be set forth in this Section.

The perimeter walls of a #building or other structure# are those portions of the outermost walls enclosing the #floor area# within a #building or other structure# at any level and height is measured from the #base plane#. Perimeter walls are subject to setback regulations at a maximum height above the #base plane# of 25 feet.

Above these heights, sloping planes control the maximum height of the #building or other structure# requiring either a setback or a pitched roof. These planes start at the maximum permitted height of the perimeter walls and meet at a ridge line of 35 feet above the #base plane#. The exact locations of these planes are flexible and are determined in the following steps set forth in paragraphs (a) through (g):

- (a) At a height of 35 feet above and parallel to the #base plane#, a plane is projected above the area enclosed by and including the perimeter walls of the #building or other structure#. A second plane (the perimeter wall plane) is projected in the same manner at a height of 25 feet above the #base plane#. (See Figure A)

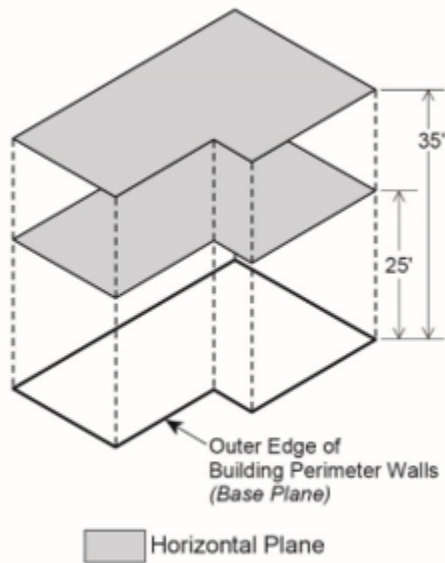

Figure A

- (b) Each perimeter wall of the #building or other structure# with a horizontal dimension of eight feet or more which projects from an adjacent perimeter wall at least 18 inches may have an apex point directly above it on the 35-foot-high plane. (See Figure B). The location of the apex point is flexible provided it is directly above its perimeter wall and provided a line drawn from the intersection of two perimeter walls to such an apex point does not exceed 80 degrees to the horizontal. An apex point is not required for each qualifying perimeter wall; however, the maximum number of apex points above each such wall is one.

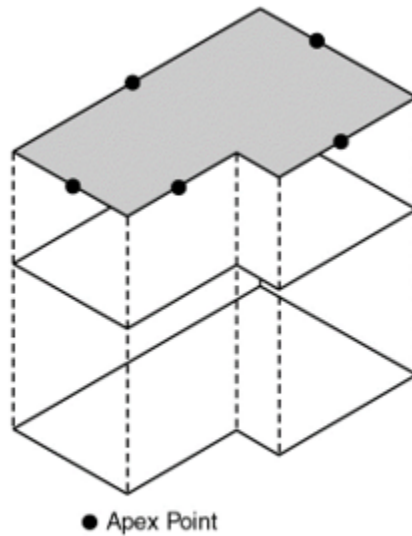

Figure B

- (c) One “ridge line” is extended in a straight line from each apex point along the 35-foot-high plane. Ridge lines which connect two apex points may cross other ridge lines. Otherwise, ridge lines which extend from only one apex point must terminate at a point of intersection with another ridge line. (See Figure C)

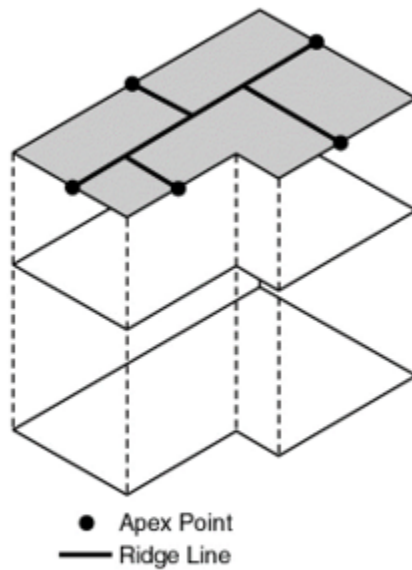

Figure C

- (d) Sloping planes are extended in a straight line outward and downward from each ridge line until they intersect the perimeter wall plane. Every sloping plane generated must intersect the perimeter wall plane for the full width of the ridge line from which it extends. (See Figure D). The maximum angle of pitch for any sloping plane may not exceed 80 degrees to the horizontal. Sloping planes extended from ridge lines perpendicular or within 45 degrees of being perpendicular to each other may intersect, in which case the higher plane defines the limit of the envelope. Sloping planes extended from ridge lines parallel or within 45 degrees of being parallel to each other must intersect the perimeter wall plane without intersecting each other.

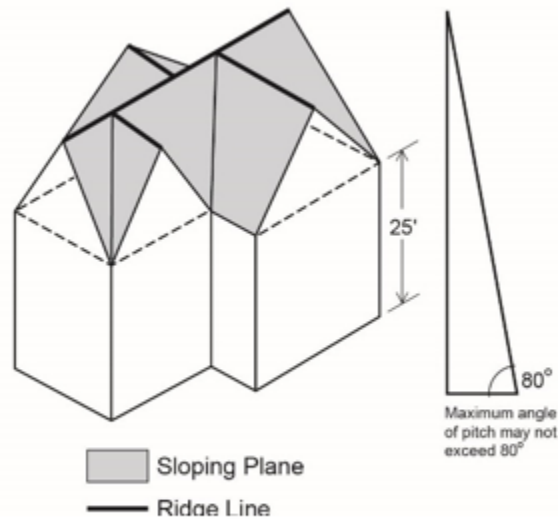

Figure D

- (e) The perimeter walls are then extended vertically beyond the perimeter wall plane, up to the heights defined by the sloping planes generated in paragraph (d). (See Figure E). The perimeter walls of the #building or other structure#, the sloping planes and the perimeter wall extensions define the #building# envelope. (See Figure F).

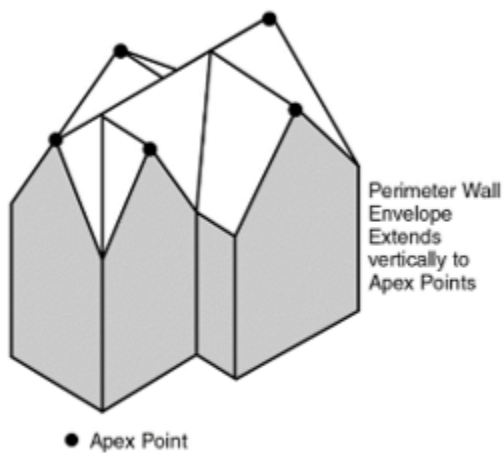

Figure E

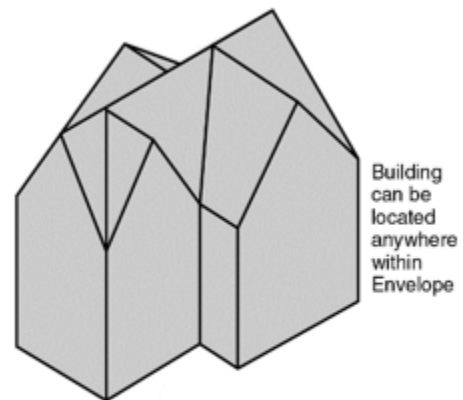

Figure F

(f) Special Situations

For convex curved perimeter walls, the #building or other structure# must be within a plane curve tapering uniformly to a vertex located at a height of 35 feet. For concave curved perimeter walls, the #building or other structure# must lie within a plane curve extending from the maximum perimeter wall height to a ridge line parallel to the prolongation of the perimeter wall at the 35-foot level. Such plane curves may not exceed a pitch of 80 degrees in relation to a plane drawn parallel to the #base plane# at the maximum height of the permitted perimeter wall. (See Figure G).

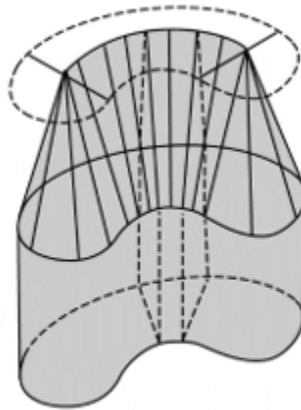

Figure G

(g) In R1 and R2 Districts without a letter suffix, for #zoning lots# that either:

- (1) have a #lot area# of at least 9,500 square feet and #lot width# of at least 100 feet; or
- (2) have a slope, as measured from the #street wall line level# to the #rear wall line level#, of at least five percent to the horizontal;

the reference plane for applying the regulations of this Section may be located up to five feet above the #base plane#.