



## Zoning Resolution

THE CITY OF NEW YORK

Eric Adams, Mayor

CITY PLANNING COMMISSION

Daniel R. Garodnick, Chair

# **24-552 - Required rear setbacks for tall buildings**

File generated by <https://zr.planning.nyc.gov> on 3/15/2025

---

## 24-552 - Required rear setbacks for tall buildings

---

LAST AMENDED

12/5/2024

R1 R2 R3 R4 R5 R6 R7 R8 R9 R10 R11 R12

In the districts indicated without a letter suffix, no portion of a #building# more than 125 feet above yard level shall be nearer to a #rear yard line# than 20 feet. However, this provision shall not apply to any portion of a #building# that qualifies as a tower under the provisions of Section [24-54](#).

In the case of a #through lot# on which a #rear yard equivalent# is provided as set forth in paragraph (a) of Section [24-382](#), the requirements of this Section shall apply as if such #rear yard equivalent# were two adjoining #rear yards#. If a #rear yard equivalent# is provided as set forth in paragraphs (b) or (c) of Section [24-382](#), the requirements of this Section shall not apply.

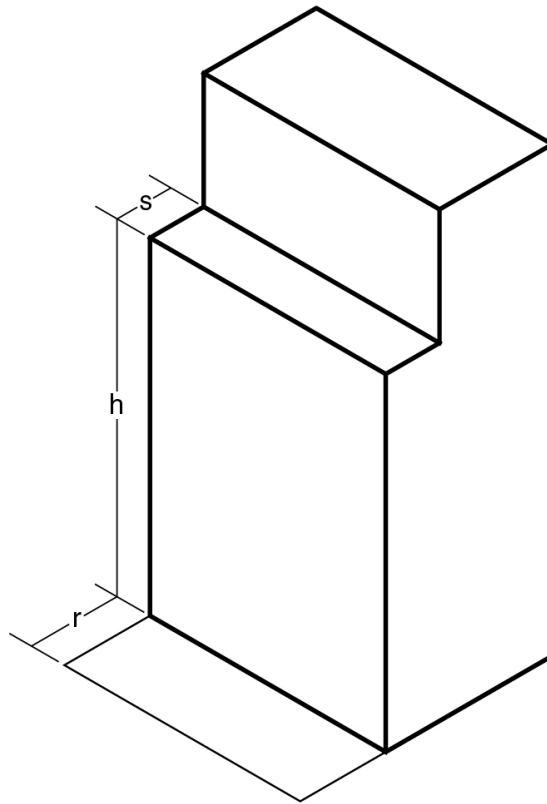

h - Height of wall above *rear yard*

r - Depth of required *rear yard*

s - Depth of required *rear yard* setback

REAR SETBACK FOR TALL BUILDINGS