



## Zoning Resolution

THE CITY OF NEW YORK

Eric Adams, Mayor

CITY PLANNING COMMISSION

Daniel R. Garodnick, Chair

# **43-40 - HEIGHT AND SETBACK REGULATIONS**

File generated by <https://zr.planning.nyc.gov> on 6/26/2022

---

## 43-40 - HEIGHT AND SETBACK REGULATIONS

---

LAST AMENDED  
12/15/1961

---

### 43-41 - Definitions

---

LAST AMENDED  
11/19/1987

Words in italics are defined in Section 12-10 (DEFINITIONS) or, if applicable exclusively to this Section, in this Section.

---

### 43-42 - Permitted Obstructions

---

LAST AMENDED  
4/30/2012

In all #Manufacturing Districts#, the following obstructions shall be permitted to penetrate a maximum height limit or a #sky exposure plane# set forth in Sections 43-43 (Maximum Height of Front Wall and Required Front Setbacks), 43-44 (Alternate Front Setbacks) or 43-49 (Limited Height Districts).

- (a) Awnings and other sun control devices, provided that when located at a level higher than the first #story#, excluding a #basement#, all such awnings and other sun control devices:
- (1) shall be limited to a maximum projection from a #building# wall of 2 feet, 6 inches, except when located on the first #story# above a setback;
  - (2) shall have solid surfaces that, in aggregate, cover an area no more than 30 percent of the area of the #building# wall (as viewed in elevation) from which they project; and
  - (3) may rise above the permitted #building# height, up to the height of a parapet wall or guardrail permitted in accordance with this Section.

When located on the first #story# above a setback, awnings and other sun control devices shall be limited to a projection of 50 percent of the depth of the required setback, and shall be limited, in total, to 50 percent of the width of the #building# wall from which they project;

- (b) #Building# columns, having an aggregate width equal to not more than 20 percent of the #aggregate width of street walls# of a #building#, to a depth not exceeding 12 inches, in an #initial setback distance#, optional front open area, or any other required setback distance or open area set forth in Sections 43-43, 43-44 or 43-45 (Tower Regulations);
- (c) Chimneys or flues, with a total width not exceeding 10 percent of the #aggregate width of street walls# of a #building# at any given level;
- (d) Decks, and other surfaces for recreational activities, not more than 3 feet, 6 inches in height, as measured from the maximum height limit, or the finished level of the roof as it existed on April 30, 2012, whichever is higher;
- (e) Elevator or stair bulkheads (including shafts; and vestibules not larger than 60 square feet in area providing access to a roof), roof water tanks and #accessory# mechanical equipment (including enclosures), other than solar or wind energy systems, provided that:

- (1) such obstructions shall be located not less than 10 feet from the #street wall# of a #building#, except that such obstructions need not be set back more than 25 feet from a #narrow# #street line# or more than 20 feet from a #wide# #street line#. However, such restrictions on location shall not apply to elevator or stair bulkheads (including shafts or vestibules), provided the #aggregate width of street walls# of such bulkheads within 10 feet of a #street wall#, facing each #street# frontage, times their average height, in feet, does not exceed an area equal to four times the width, in feet, of the #street wall# of the #building# facing such frontage;
- (2) all mechanical equipment shall be screened on all sides;
- (3) such obstructions and screening are contained within a volume that complies with one of the following:
  - (i) the product, in square feet, of the #aggregate width of street walls# of such obstructions facing each #street# frontage, times their average height, shall not exceed an area equal to eight times the width, in feet, of the #street wall# of the #building# facing such frontage; or
  - (ii) the #lot coverage# of all such obstructions does not exceed 20 percent of the #lot coverage# of the #building#, and where the maximum permitted height of a #building# is less than 120 feet, such obstructions are limited to a maximum height of 25 feet, and where the maximum permitted height of a #building# is 120 feet or greater, such obstructions are limited to a maximum height of 40 feet.

For the purposes of this paragraph, (e), #abutting# #buildings# on a single #zoning lot# may be considered to be a single #building#;

- (f) Exterior wall thickness, up to eight inches, where such wall thickness is added to the exterior face of a #building# wall existing on April 30, 2012, provided the added wall thickness has a thermal resistance (R-value) of at least 1.5 per inch. Where #buildings# that have added exterior wall thickness pursuant to this Section are #enlarged#, such #enlarged# portion may similarly penetrate a maximum height limit in order to align with the exterior walls of the existing #building#, provided such #enlargement# contains less #floor area# than the existing #building#, and there is no penetration of #floor area# above a maximum height limit;
- (g) Flagpoles or aerials;
- (h) House of worship towers, ornamental, having no #floor area# in portion of tower penetrating such height limit or #sky exposure plane#;
- (i) Parapet walls, not more than four feet in height, as measured from the maximum height limit, or the finished level of the roof as it existed on April 30, 2012, whichever is higher. A guardrail with a surface at least 70 percent open or with an opacity of not more than 30 percent (as viewed in elevation), shall be permitted above a parapet wall or within two feet of a parapet wall, provided such guardrail is not more than four feet above the accessible level of a roof. Such restriction on guardrail height shall not apply when located beyond two feet from a parapet wall;
- (j) Roof thickness, up to eight inches, to accommodate the addition of insulation, for #buildings# or portions of #buildings# constructed prior to April 30, 2012. For a #building# that has added roof thickness pursuant to this paragraph, (j), an #enlargement# may align with the finished roof surface of such #building#, provided the #enlarged# portion does not exceed the maximum height limit by more than eight inches;
- (k) Rooftop greenhouses, permitted pursuant to Section 75-01 (Certification for Rooftop Greenhouses);
- (l) Skylights, clerestories or other daylighting devices, not more than four feet in height, as measured from the maximum height limit, or the finished level of the roof as it existed on April 30, 2012, whichever is higher. Such devices shall be limited to a #lot coverage# not greater than 10 percent of the #lot coverage# of the roof and be located at least eight feet from the #street wall# edge. However, such devices shall not be permitted obstructions above a roof with a slope greater

than 20 degrees;

(m) Solar energy systems:

- (1) on the roof of a #building#, up to four feet in height, as measured from the maximum height limit, or the finished level of the roof, whichever is higher;
- (2) on the roof of a #building#, greater than four feet in height, as measured from the maximum height limit, or the finished level of the roof, whichever is higher, provided that all such portions above four feet are set back at least six feet from a #street wall#, limited to a #lot coverage# not greater than 25 percent of the #lot coverage# of the roof and do not exceed:
  - (i) a height of 15 feet;
  - (ii) a height of six feet when located on a bulkhead or other obstruction, pursuant to paragraph (e) of this Section;
- (3) on walls existing on April 30, 2012, projecting no more than 10 inches and occupying no more than 20 percent of the surface area of the #building# wall (as viewed in elevation) from which it projects.

However, any installation on a roof with a slope greater than 20 degrees shall be limited to 18 inches in height, as measured perpendicular to the roof surface;

(n) Spires or belfries;

(o) Vegetated roofs, not more than 3 feet, 6 inches in height, excluding vegetation, as measured from the maximum height limit, or the finished level of the roof as it existed on April 30, 2012, whichever is higher. On roofs with slopes greater than 20 degrees, vegetated roofs shall be limited to a height of 12 inches measured perpendicular to such roof surface;

(p) Weirs, check dams and other equipment for stormwater management, not more than 3 feet, 6 inches in height, as measured from the maximum height limit, or the finished level of the roof as it existed on April 30, 2012, whichever is higher;

(q) Wind energy systems on portions of #buildings# with a height of 100 feet or greater, provided:

- (1) the highest point of the wind turbine assembly does not exceed 55 feet;
- (2) no portion of the wind turbine assembly is closer than 10 feet to any #lot line#; and
- (3) in districts where #residences# or #joint living-work quarters for artists# are permitted as-of-right, by special permit or by authorization, or within 100 feet of such districts, the diameter of the swept area of the rotor does not exceed 15 feet;

(r) Window washing equipment mounted on a roof;

(s) Wire, chain link or other transparent fences.

---

### **43-43 - Maximum Height of Front Wall and Required Front Setbacks**

---

LAST AMENDED  
9/21/2011

M1 M2 M3

In all districts, as indicated, if the front wall or any other portion of a #building or other structure# is located at the #street line# or within the #initial setback distance# as set forth in the table in this Section, the height of such front wall or other portion of a #building or other structure#, except as otherwise set forth in this Section, shall not exceed the maximum height above #curb level# set forth in the table. Above such maximum height and beyond the #initial setback distance#, the #building or other structure# shall not penetrate the #sky exposure plane# set forth in the table.

The regulations of this Section shall apply, except as otherwise provided in Sections 43-42 (Permitted Obstructions), 43-44 (Alternate Front Setbacks) or 43-45 (Tower Regulations). In M1-1 Districts, for #community facility buildings#, the maximum height of a front wall shall be 35 feet or three #stories#, whichever is less, and the height above the #street line# shall be 35 feet, and in M1-4 Districts, for #community facility buildings#, the maximum height of a front wall shall be 60 feet or six #stories#, whichever is less.

For #zoning lots# in M1-6 Districts that are both within 100 feet of the western #street line# of Seventh Avenue and between West 28th and West 30th Streets in the Borough of Manhattan, the following #street wall# regulations shall apply to #street# frontages not occupied by a #public plaza#. The #street wall# of a #building# shall be located on the #street line# and extend along the entire #street# frontage of the #zoning lot# up to a minimum height of 125 feet or the height of the #building#, whichever is less, and a maximum height of 150 feet. Above a height of 150 feet, no portion of a #building# may penetrate a #sky exposure plane# except for towers, pursuant to Section 43-45. The #sky exposure plane# shall begin at a height of 150 feet above the #street line# and rise over the #zoning lot# at a slope of 5.6 feet of vertical distance for each foot of horizontal distance on a #wide street#, and at a slope of 2.7 feet of vertical distance for each foot of horizontal distance on a #narrow street#. The provisions of Section 43-44 shall not apply. On the ground floor, recesses shall be permitted where required to provide access to the #building#, provided such recesses do not exceed three feet in depth as measured from the #street line#. Above the level of the second #story#, up to 30 percent of the #aggregate width of street walls# may be recessed beyond the #street line#. However, no recesses shall be permitted within 20 feet of an adjacent #building# and within 30 feet of the intersection of two #street lines#.

**MAXIMUM HEIGHT OF FRONT WALL AND REQUIRED FRONT SETBACKS**

#Initial Setback Distance# (in feet)		Maximum Height of a Front Wall, or other Portion of a #Building or other structure# within the #Initial Setback Distance#	#Sky Exposure Plane#				
			Height above #Street Line# (in feet)	Slope over #Zoning Lot# (expressed as a ratio of vertical distance to horizontal distance)			
On #Narrow Street#	On #Wide Street#			On #Narrow Street#		On #Wide street#	
			Vertical Distance	Horizontal Distance	Vertical Distance	Horizontal Distance	
Within M1-1 Districts							
20	15	30 feet or 2 #stories#, whichever is less	30	1 to	1	1 to	1

Within M1-2, M1-4, M2-1, M2-3 or M3 Districts							
20	15	60 feet or 4 #stories#, whichever is less	60	2.7 to	1	5.6 to	1
Within M1-3, M1-5, M1-6, M2-2 or M2-4 Districts							
20	15	85 feet or 6 #stories#, whichever is less	85	2.7 to	1	5.6 to	1

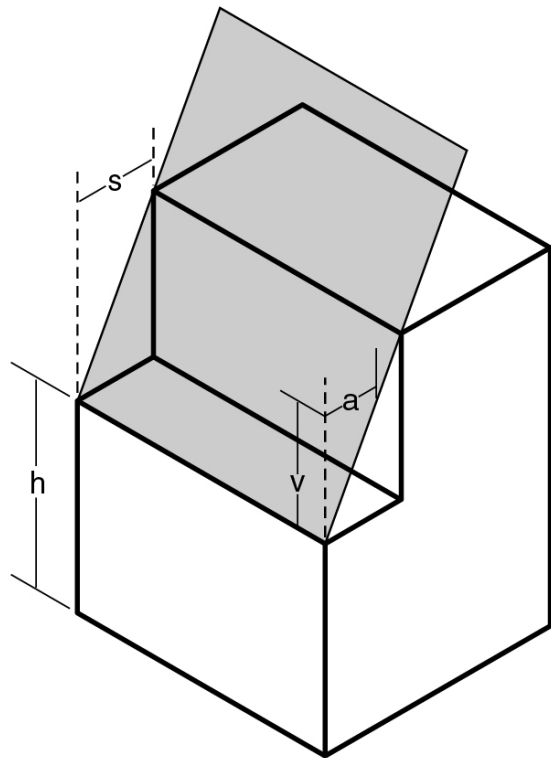

a - Horizontal distance                      s - Initial setback distance  
 h - Height of sky exposure plane above street line      v - Vertical distance

 Sky Exposure Plane

**SKY EXPOSURE PLANE**  
 (23 - 641, 24 - 522, 33 - 432, 43 - 43)

---

**43-44 - Alternate Front Setbacks**

---

M1 M2 M3

In all districts, as indicated, if an open area is provided along the full length of the #front lot line# with the minimum depth set forth in the following table, the provisions of Section 43-43 (Maximum Height of Front Wall and Required Front Setbacks) shall not apply. The minimum depth of such open area shall be measured perpendicular to the #front lot line#. However, in such instances, except as otherwise provided in this Section or in Sections 43-42 (Permitted Obstructions) or 43-45 (Tower Regulations), no #building or other structure# shall penetrate the alternate #sky exposure plane# set forth in the table in this Section. The #sky exposure plane# shall be measured from a point above the #street line#.

In an M1-6 District, if the open area provided under the terms of this Section is a #public plaza#, such open area may be counted toward the bonus provided for a #public plaza#, pursuant to Section 43-13 (Floor Area Bonus for Public Plazas).

In M1-1 Districts, for #community facility buildings# the height above the #street line# shall be 35 feet.

ALTERNATE REQUIRED FRONT SETBACKS

Depth of Optional Front Open Area (in feet)		Alternate #Sky Exposure Plane#				
		Slope over #Zoning Lot# (expressed as a ratio of vertical distance to horizontal distance)				
		On #Narrow Street#		On #Wide Street#		
On #Narrow Street#	On #Wide Street#	Height above #Street Line# (in feet)	Vertical Distance	Horizontal Distance	Vertical Distance	Horizontal Distance
Within M1-1 Districts						
15	10	30	1.4 to	1	1.4 to	1

Within M1-2, M1-4, M2-1, M2-3 or M3 Districts						
15	10	60	3.7 to	1	7.6 to	1
Within M1-3, M1-5, M1-6, M2-2 or M2-4 Districts						
15	10	85	3.7 to	1	7.6 to	1

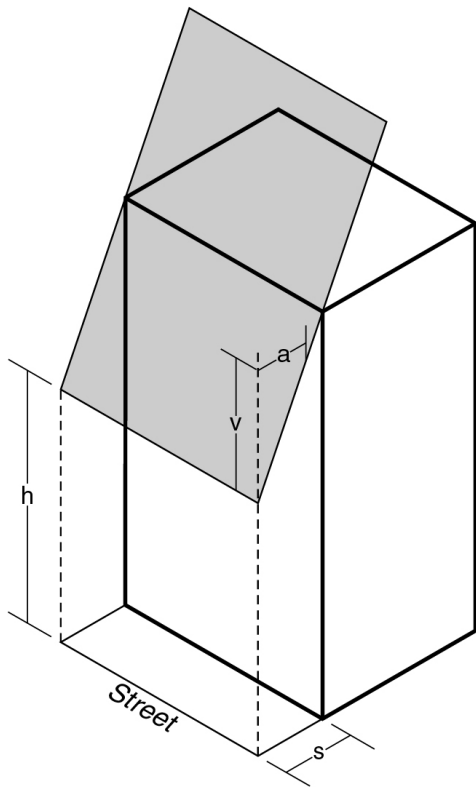

- a - Horizontal distance
- h - Height of sky exposure plane above street line
- s - Depth of the optional front open area
- v - Vertical distance

Sky Exposure Plane

**ALTERNATE SKY EXPOSURE PLANE**

(23 - 64, 24 - 53, 33 - 442, 43 - 44)



## 43-45 - Tower Regulations

---

LAST AMENDED

2/2/2011

M1-3 M1-4 M1-5 M1-6

In the districts indicated, any #building# or #buildings#, or portion thereof, which in the aggregate occupy not more than 40 percent of the #lot area# of a #zoning lot# or, for #zoning lots# of less than 20,000 square feet, the percent set forth in Section 43-451 (Towers on small lots), may penetrate an established #sky exposure plane#. (Such #building# or portion thereof is hereinafter referred to as a tower.) At any given level, such tower may occupy any portion of the #zoning lot# not located less than 15 feet from the #street line# of a #narrow street#, or less than 10 feet from the #street line# of a #wide street#, provided that the aggregate area so occupied within 50 feet of a #narrow street# shall not exceed 1,875 square feet and the aggregate area so occupied within 40 feet of a #wide street# shall not exceed 1,600 square feet.

If all of the #buildings# on a #zoning lot# containing such tower do not occupy at any level more than the maximum percent of the #lot area# set forth in this Section or Section 43-451 for towers, the tower may occupy any portion of the #zoning lot# located 20 feet or more from the #street line# of a #narrow street# or 15 feet or more from the #street line# of a #wide street#, provided that the aggregate area so occupied within 50 feet of a #narrow street# shall not exceed 2,250 square feet and the aggregate area so occupied within 40 feet of a #wide street# shall not exceed 2,000 square feet.

---

### 43-451 - Towers on small lots

---

LAST AMENDED

12/15/1961

M1-3 M1-4 M1-5 M1-6

In the districts indicated, a tower may occupy the percent of the #lot area# of a #zoning lot# set forth in the following table:

#### LOT COVERAGE OF TOWERS ON SMALL ZONING LOTS

Area of #Zoning Lot# (in square feet)	Maximum Percent of #Lot Coverage#
10,500 or less	50
10,501 to 11,500	49
11,501 to 12,500	48

12,501 to 13,500	47
13,501 to 14,500	46
14,501 to 15,500	45
15,501 to 16,500	44
16,501 to 17,500	43
17,501 to 18,500	42
18,501 to 19,999	41

---

### **43-46 - Special Provisions for Zoning Lots Directly Adjoining Public Parks**

---

LAST AMENDED  
12/15/1961

M1 M2 M3

In all districts, as indicated, a #public park# with an area of between one and 15 acres shall be considered a #wide street# for the purpose of applying the height and setback regulations as set forth in Section 43-43 (Maximum Height of Front Wall and Required Front Setbacks) to any #building or other structure# on a #zoning lot# adjoining such #public park#. However, the provisions of this Section shall not apply to a #public park# more than 75 percent of which is paved.

---

### **43-47 - Modification of Height and Setback Regulations**

---

LAST AMENDED  
12/15/1961

M1

In the district indicated, for certain #community facility# #uses# in specified situations, the Board of Standards and Appeals may modify the regulations set forth in Sections 43-41 to 43-45, inclusive, relating to Height and Setback Regulations, in accordance with the provisions of Section 73-64 (Modifications for Community Facility Uses).

---

### **43-48 - Special Provisions for Zoning Lots Divided by District Boundaries**

---

LAST AMENDED  
12/15/1961

M1 M2 M3

In all districts, as indicated, whenever a #zoning lot# is divided by a boundary between districts with different height and setback regulations, or whenever a #zoning lot# is divided by a boundary between a district to which the provisions of Section 43-45 (Tower Regulations) apply and a district to which such provisions do not apply, the provisions set forth in Article VII, Chapter 7 shall apply.

---

### **43-49 - Limited Height Districts**

---

LAST AMENDED  
3/4/1982

M1 M2 M3

In all districts, as indicated, wherever such districts are located within a #Limited Height District#, the maximum height of a #building or other structure#, or portion thereof, shall be as shown in the following table:

#Limited Height District#	Maximum Height above #Curb Level#
LH-1	50 feet
LH-1A	60 feet
LH-2	70 feet
LH-3	100 feet